

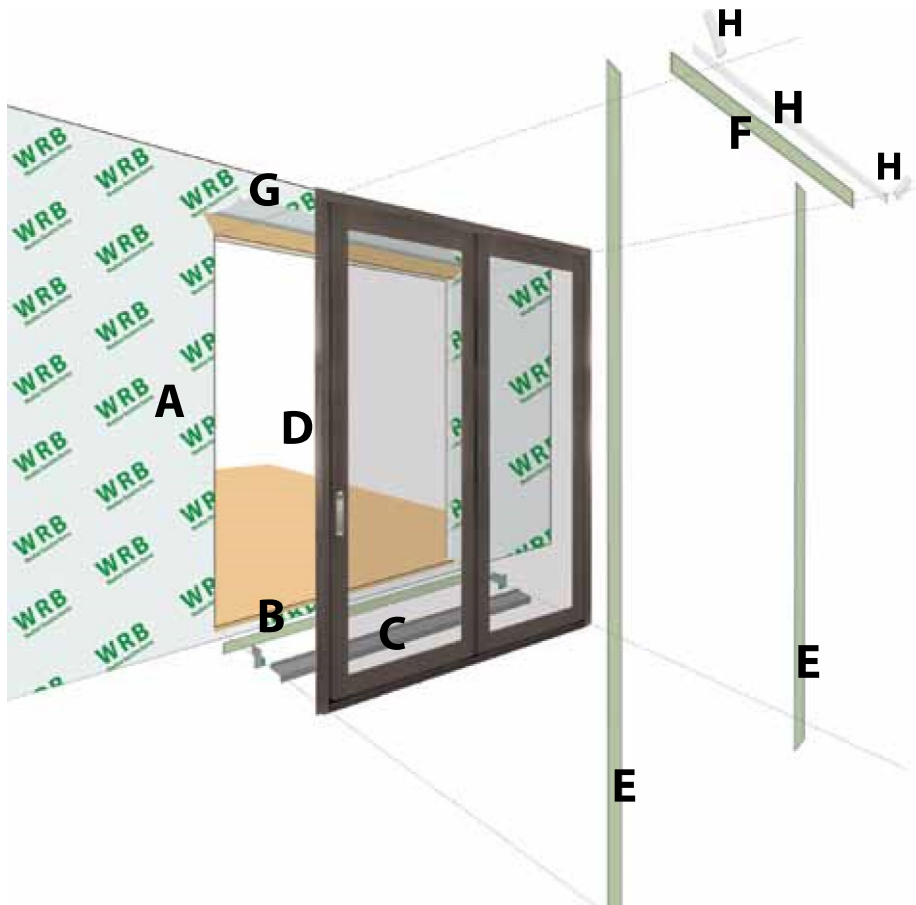

New Construction Sliding Door Installation Instructions



- A. Apply Weather Resistive Barrier
- B. Apply Bottom Flashing Tape
- C. Install Sill Pan End Caps & Pan
- D. Caulk Sides & Top Nailing Surface, Set Door, Fasten
- E. Apply Side Flashing Tape
- F. Apply Top Flashing Tape
- G. Fold Down WRB Top Flap
- H. Apply WRB Tape to Flap Seams, bottom first then sides

Needed:

- Polyurethane Sealant
(AAMA 808 compliant for windows and doors)
- 1-1/2" to 2" Galvanized Roofing Nails
- Self-Adhesive Flashing Tape
- Sill Pan
- Weather Resistive Barrier & Tape
- Foam Backer Rod
- Low Expanding Window & Door Foam
- Window & Door Shims

Safety glasses, tape measure, level, putty knife, utility knife, hammer, staple gun, screw gun, caulk gun, other

ATTENTION! Read and understand all installation instructions before installing this product.

1

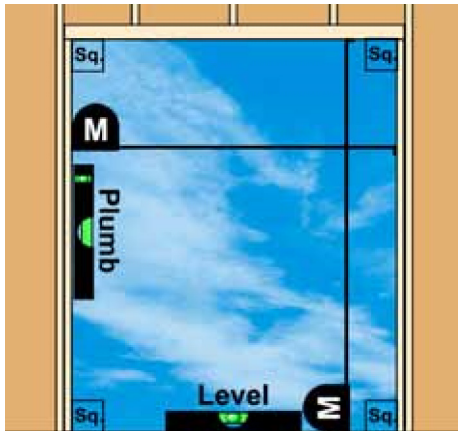

The Rough Opening

- a) Frame the Rough Opening to the correct size for the door, allowing a minimum of 1/4" clearance on the sides and 1/2" at the head.
- b) Floor surface at sill **ABSOLUTELY MUST BE LEVEL!**
Verify that the Sill/Floor is level. If not, do not proceed until you resurface the sill floor surface to level.
- c) Sides must be plumb.
- d) Head must be level.
- e) Corners must be square for rectangular products.

- Additional support framing for Radius and Special Shape products must be added as needed.
- Additional support framing is required for Clad Exterior Trim options to provide stud framing behind nailing fin area.

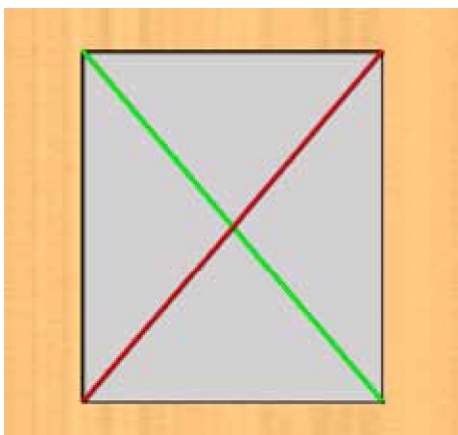

Avoiding Call Backs Tip!

Wall Must Be In True Plane

Why? - Failure to have a True Framing Plane will create a twist in the product frame which will make it difficult to close properly and latch.

Check wall by running two strings diagonally across the opening with the corners flush against the exterior wall surface. One string will overlap the other in the center. If the strings don't touch in the center, or if one pulls the other down, the wall is not framed in a true plane. Double check by reversing the overlapping strings.

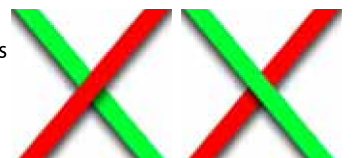



New Construction Sliding Door Installation Instructions

2



Test fit door in the opening

- a) Remove the packaging from the door. This includes the clear wrap, cardboard protectors, plastic bottom corner supports (and screws) and transportation handles (and screws).
- b) Place the door in the opening and check all clearances. You should have approximately 1/4" on the sides and 1/2" at the top. Remove the door and make any necessary adjustments to the framing now.

3a



Integrating The Weather Resistive Barrier

- a) Apply Weather Resistive Barrier (WRB) to the exterior wall surface per manufacturers instructions.
- b) Cut WRB over window opening as indicated in the illustrations. Cut 1" above the top of the opening to allow for taping of this flap to the top flashing. See step 21. Cut 1" below the bottom to expose the sheathing for step 3e below.
- c) Wrap sides into opening. Fasten. Trim excess.
- d) Temporarily fold up top flap and tape out of the way in preparation for setting the door.
- e) Apply a piece of Flashing Tape across the Step Down, overlapping the sheathing and WRB.

3b

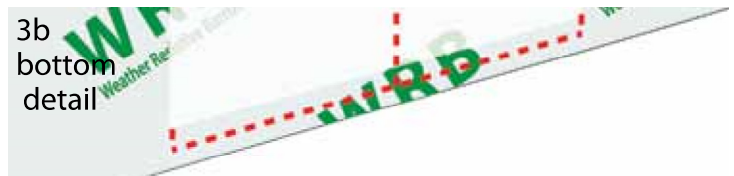
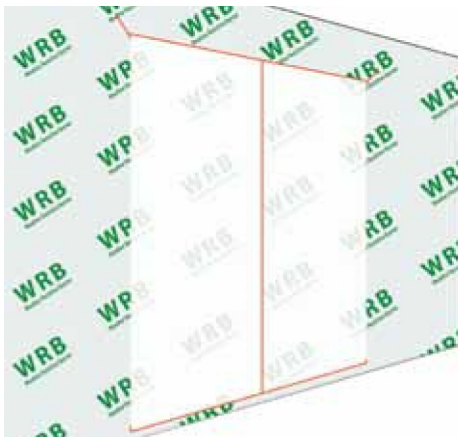

3c-d

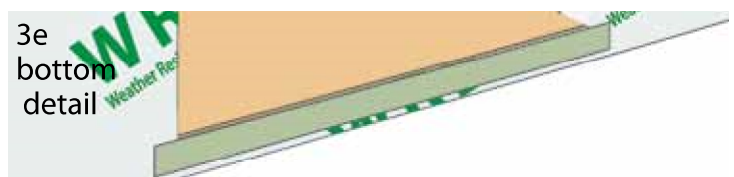
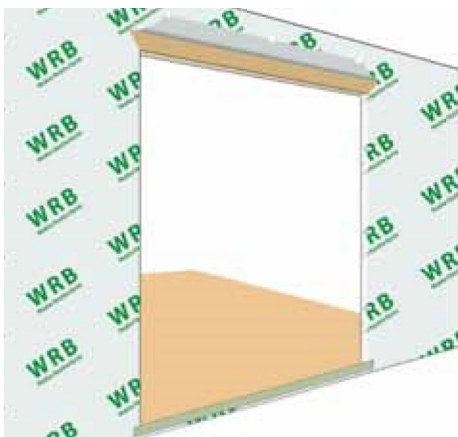



New Construction Sliding Door Installation Instructions

4

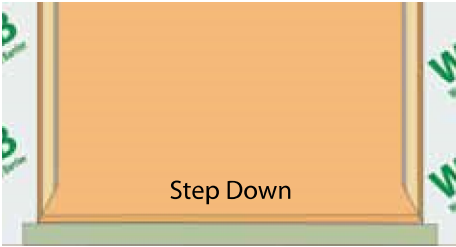
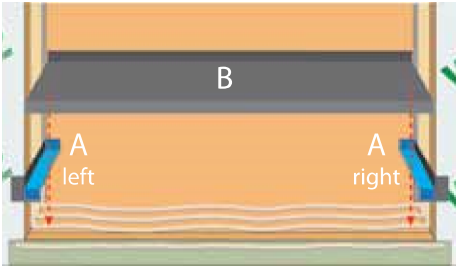

Avoiding Call Backs Tip!

Installing a Sill Pan, prior to installing a door, can help prevent damage caused by water infiltration from a variety of potential sources.

Install The Sill Pan

Door sill pan contains 3 parts:
A End Caps (2 - left & right)
B Sill pan (1)

Note: The Sill Pan Must Be Installed On A Level Surface.

Determine Sill Type Step Down or Flush To The Floor

Step Down - If the installation has an exterior that steps down from the interior floor, the sill pan and end caps are ready to use as packaged.

Flush To Floor - If the installation is flush to the floor, the sill pan and end caps must have the bottom Step Down lip removed.

If the installation is on a **Step Down**, proceed to **next step**.

Trim Lip: ONLY for Flush to the Floor applications

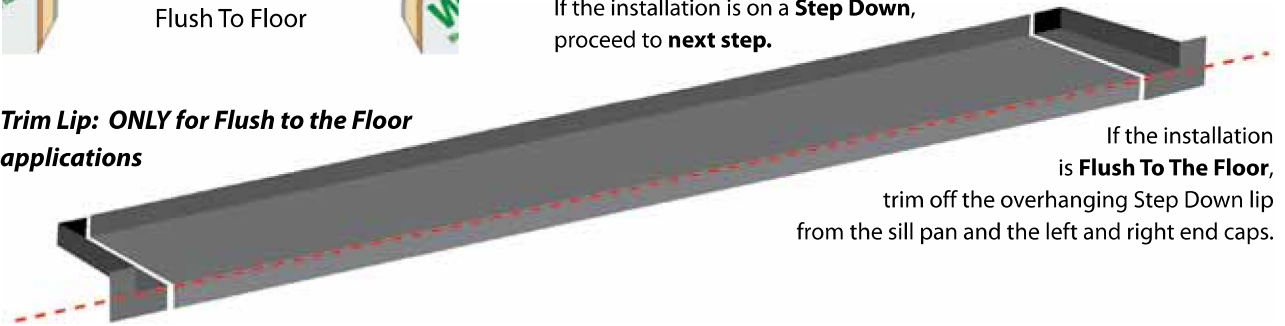

If the installation is **Flush To The Floor**, trim off the overhanging Step Down lip from the sill pan and the left and right end caps.

5

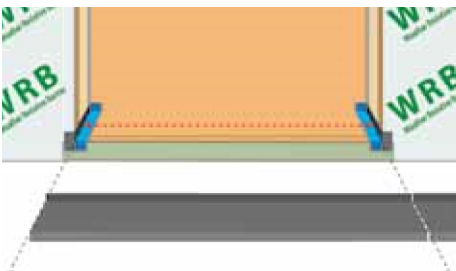

Cut The Sill Pan To Fit Width

Place the left and right sill pan **End Caps** tightly in each corner of the rough opening and measure the distance between to determine the cut length for the sill pan. Cut the sill pan to the measured length. Before moving to the next step, remove both end caps.

Apply Sealant To Sill Area

Using AAMA 808 compliant polyurethane sealant, apply three 3/8" beads of sealant along the entire length of the sill floor AND continue 2" up each side of the opening. For installation on a **Step Down**, also apply one 3/8" bead of the sealant to the outer edge of the step down (or the backside of the overhanging lip of the pan and end caps).

6

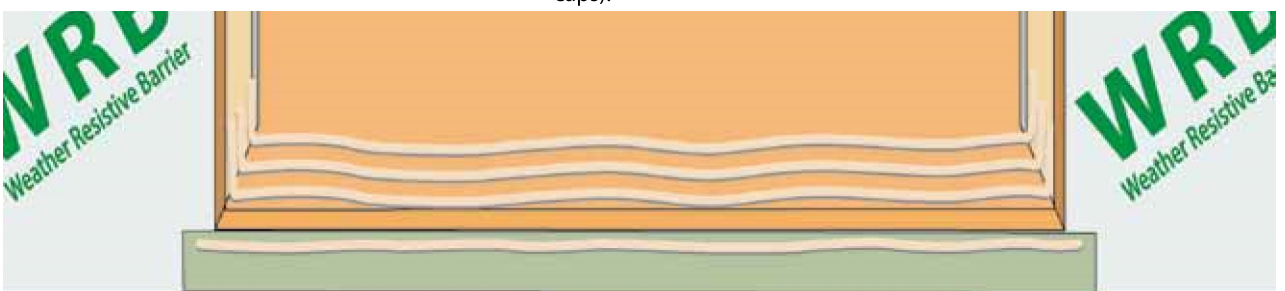



New Construction Sliding Door Installation Instructions

7

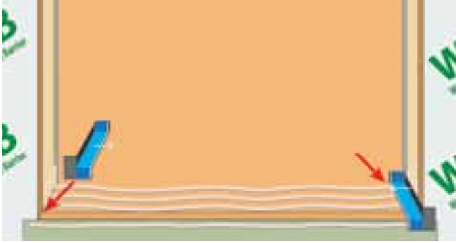

Set End Caps

Press the left and right end caps firmly into the sealant. Nail each end cap to the rough opening using the nail slot provided. Remove the adhesive tape protective cover from each end cap.

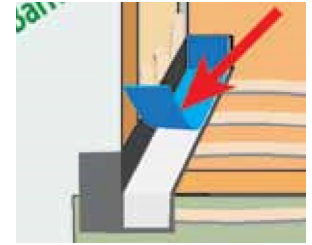

8

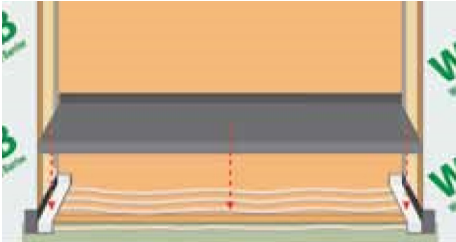

Set Sill Pan

Firmly press the sill pan into the sealant.

9

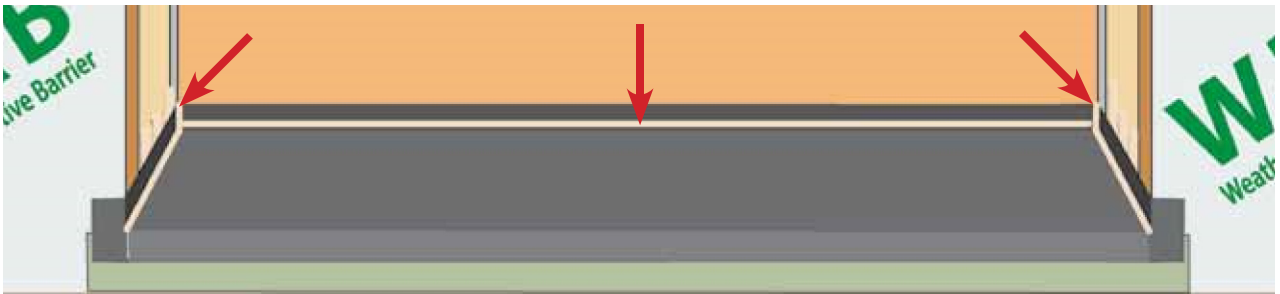

Apply Sealant

Apply one 3/8" bead of sealant in the (1) left and (2) right corners where the sill pan fits against the end caps.

Just before installing the door, apply one 3/8" continuous bead of sealant, from end to end, along the back vertical lip of the sill pan.

For flush to the floor installations, also apply one 3/8" bead of sealant to where the front outer edge of the sill pan meets the floor (3).

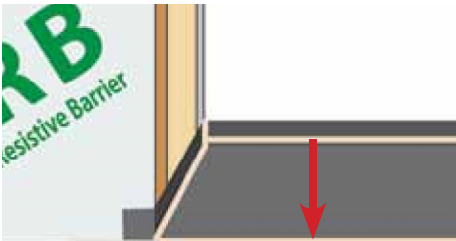

10

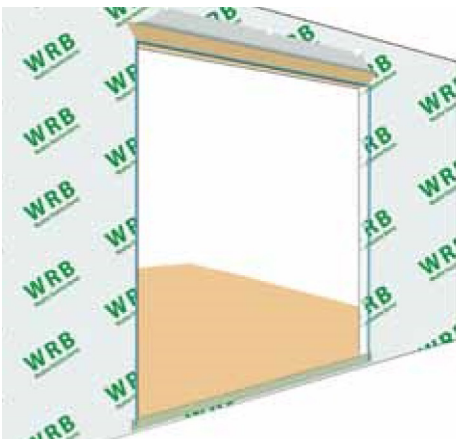

Apply Sealant to WRB Nailing Surface

Using AAMA 808 compliant polyurethane sealant, apply a continuous bead, 1/4" to 3/8" in width, to the Weather Resistive Barrier and exposed top sheathing where the nail fins will overlap these surfaces.



New Construction Sliding Door Installation Instructions

11



Set the Door in the Opening

- a) With the sealant applied, set the door in the opening.
- b) Center the unit in the opening so that there is equal space on both sides.



- c) Temporarily fasten the unit in the opening using a pair of wood blocks and screws. The wood blocks should overlap the nail fin, one on each side the unit, near the top. Apply the screw approximately 1/2" from edge of nailing fin. Loosely fasten the block just enough to hold the unit in place but allow for shifting of the frame for adjustments (see the following step for squaring the frame). Keep the hole close enough to the nail fin so that it will be covered by the flashing tape when it is applied in step 18.

Verify that the Sill is Level

Verify that the sill is level. It **ABSOLUTELY MUST BE LEVEL**. If not, remove the door and resurface the floor and sill pan to level.

12



Avoiding Call Backs Tip!

Leveling is the first step in making sure the door is installed square. A level sill ensures that water will drain properly and is the foundation for door panel to frame alignment.

Square the Door Frame

Check that the door frame is square. To do this, measure diagonally from one top corner to the opposite side bottom corner and then measure the other two corners. These measurements should be the same (within 1/16th of an inch). If they are not, the door is set in the opening out-of-square. Adjust if necessary. Shift either the top or bottom of the door frame sideways until both diagonal measurements equal each other.

13

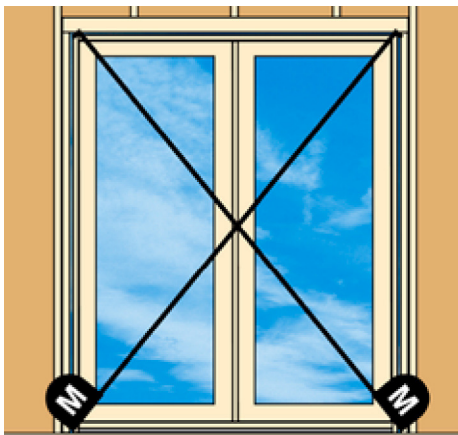

Avoiding Call Backs Tip!

Squaring the door frame ensures that the alignment relationship between the door panel and frame is correct.

If the door is not installed square, the alignment of the door panel(s) in relationship to the product frame will be off. It can keep the panel from opening or closing correctly, as well as hinder the operation of locks and latches. Air and water leakage is also likely, due to improper contact with the weather seals.



New Construction Sliding Door Installation Instructions

14

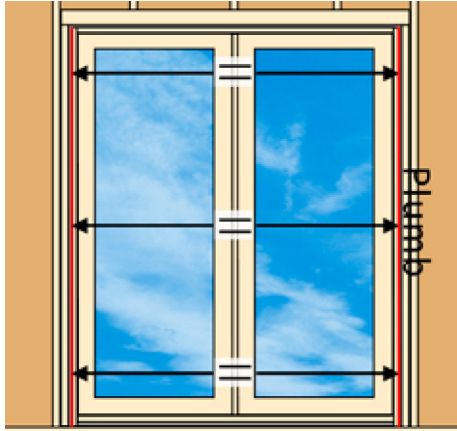

Plumb & Shim

Check the side jambs to verify that they are plumb. Shim sides of the door about 6 to 10 inches down from the top and up from the bottom. Also shim at the center point. Do not shim the top of the door.



Avoiding Call Backs Tip!

Plumbing and shimming the sides will help insure there is no bow to the sides of the door frame.

Shimming will help solidify the anchoring of the frame to the wall. This will help maintain the correct alignment between the door panel and the frame.

15



Finish Fastening Through The Nail Fin

Note: if your door has Sun Exterior Trim, as in Brick Mold or Casing, the nailing fin is actually on the extruded trim. It is to be treated the same as instructed below. The fasteners must penetrate actual stud framing.

- a) Finish fastening the door through the nail fin, applying fasteners every 8 to 10 inches all around the door. Use 1-1/2" to 2" galvanized roofing nails.
- b) Seal the heads of the fasteners with a dab of sealant.

16



Install the Active Panel

The Active Door Panel is not installed in the Sliding Door Frame at the factory. It is packaged separately to protect it, as well as the frame from damage during shipping and product handling. Follow these steps to install the panel in the door frame once it has been installed into the wall. (continued on next page)



16

Install the Active Panel:

a) Locate and remove Wind Load Bar

The Wind Load Bar is located in the head of the door frame over the active panel opening. It is pre-installed in a recessed groove and held in place with 3 screws. Remove the screws and remove the bar by pulling it downward. Set it aside with the screws. You will need to re-install it once you have set the door panel in place.

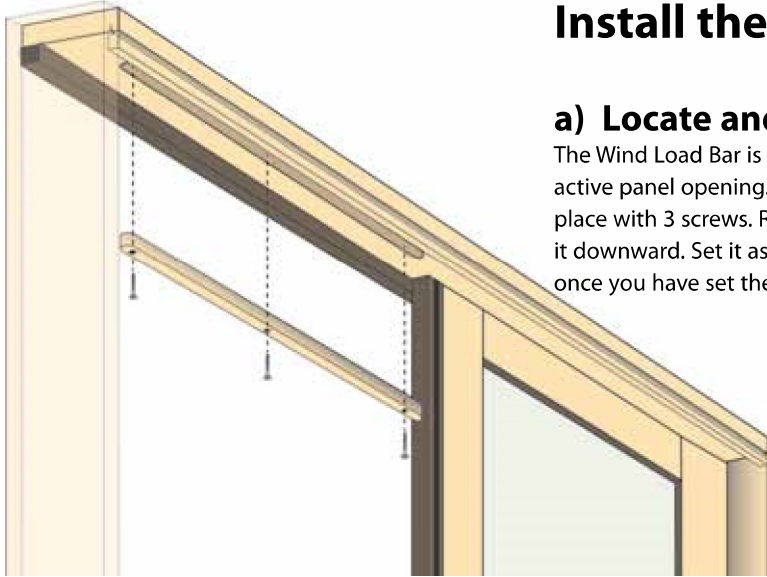

b) Locate and remove Inside Head Stop

The Interior Head Stop is located in the head of the door frame toward the interior edge of the frame. Note the profile ridge near the top of the stop. This ridge always faces the room interior, not the face of the panel. You will need to be sure to install it back into the frame the same way. It is pre-installed and held in place with a series of snap-in retaining strips. Remove the stop by carefully pulling it downward. Start at one end of the stop and pull straight downward until the retaining strips disengage from their groove. Continue across the length of the stop until it is completely free from the frame. The retaining strips may stay snapped into either the stop or their groove in the head of the frame. It is best to have them snapped into the stop, so remove any strips that might have stayed in the head groove and snap them into the stop. They should be evenly spaced across the length of the stop. Once all the retaining strips are installed back into the stop, set the stop in an easy to reach location as you will need it when you place the door panel into the opening.

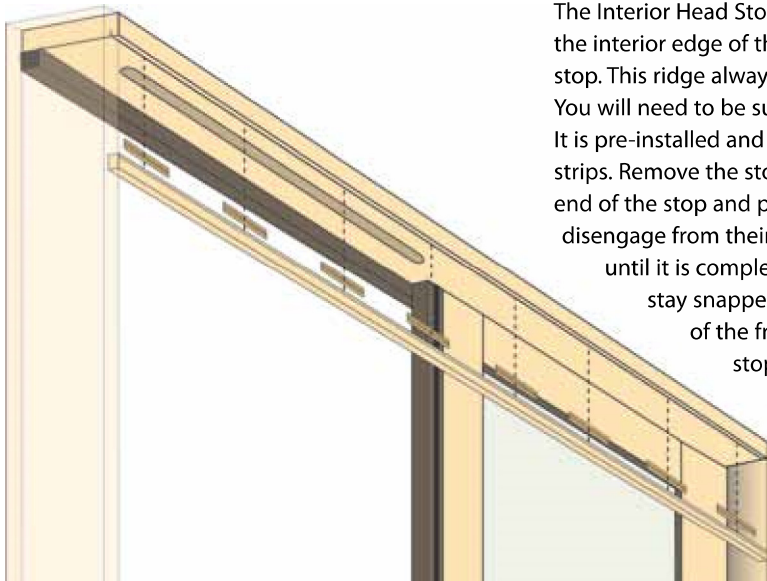

c) Set Active Door Panel into Frame **Warning: Heavy, Assistance May Be Needed**

The Active Door Panel has rollers in the bottom of the panel. These rollers must be set onto the stainless steel glide track in the sill. The door panel should be installed centered in the middle of the whole door frame. Do not attempt to install it to one side or the other. Along with your helper, lift the door panel and set the bottom into the glide track while keeping the top tilted slightly outward from the top of the frame. Once you have engaged the rollers onto the glide track, push the top of the panel into the frame opening. Test the rollers to be sure they are properly seated on the glide track by sliding the panel sideways several inches in both directions.





New Construction Sliding Door Installation Instructions



d) Install Interior Head Stop

While your helper keeps the top of the Active Door Panel pushed into place, retrieve the Interior Head Stop and snap it back into place in the top of the frame. Once snapped back into place, this will hold the top of the door in place.

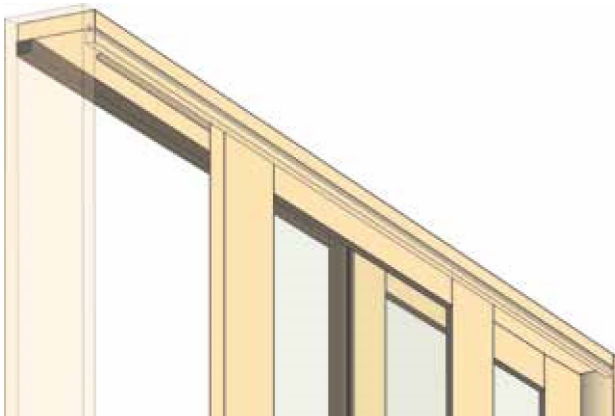

With the Interior Head Stop installed, slide the active panel into the fully open position.

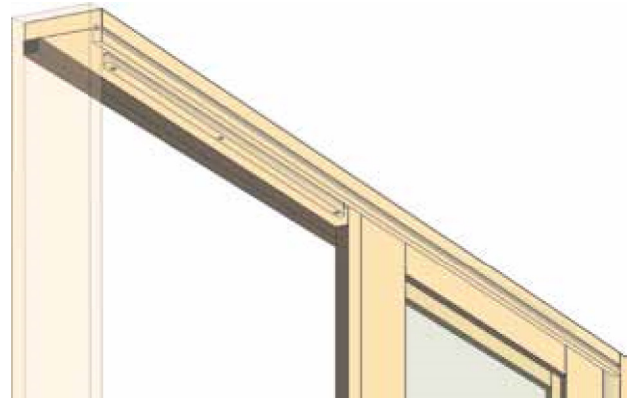
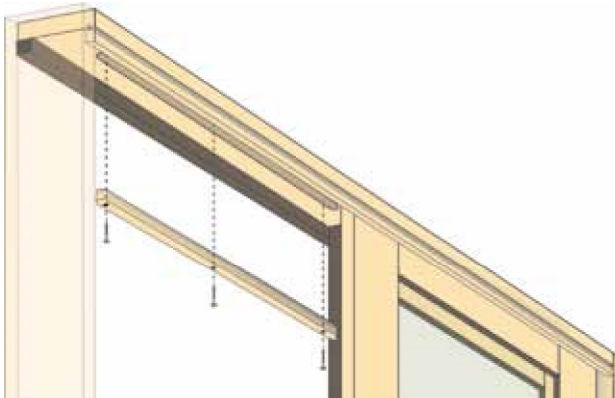
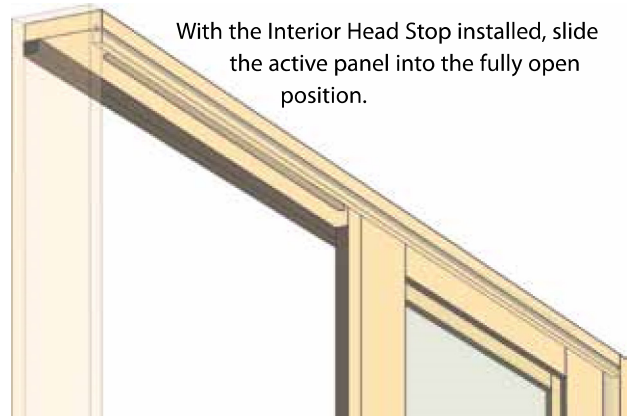

e) Install the Wind Load Bar

Retrieve the Wind Load Bar and 3 screws removed in step A and reinstall into the recessed groove in the head. Close the Active Door Panel to be sure that it operates properly.



New Construction Sliding Door Installation Instructions

17



Check Panel to Frame Reveal

From the inside, carefully examine the gap between the door panel and the frame. The gap should be uniform across the top, the bottom and down the side. If it is not, the frame was not squared properly. Go back to steps 13 and 14 and adjust until square.

18



Note: All Flashing is to be applied in Weatherboard fashion.

Apply Side Flashing

Using Self-Adhesive Flashing Tape, apply flashing so that it covers the nailing fin and overlaps the adjacent WRB. Be sure to cover the fastener heads on the nailing fin. The flashing should extend approximately 1" above the top of the nail fin and 1" below the bottom (on step down applications).

19

*Field
Mulled
Units Only!*

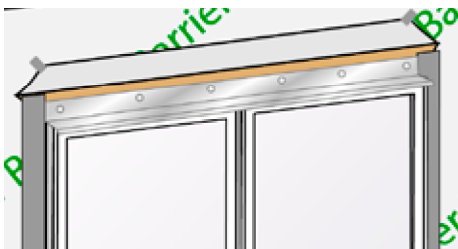

Drip Cap

Sun continuous frame door units, with their integrated nailing fin, do not require an additional drip cap. Mullered units, like doors with sidelites, do. In most cases, units that are mullered at the Sun Factory will already have the drip cap installed. Units that are mullered in the field require a drip cap to be installed across the top full width of the unit. Sun's Extruded Drip Cap snaps into the accessory groove on the door frame. Other drip caps must be fastened and sealed by other methods.

20



Apply Top Flashing

With the top WRB flap still folded out of the way (see step 3), apply Self-Adhesive Flashing Tape across the top of the door. It should cover the nailing fin, including fastener heads, and overlap the adjacent wall sheathing surface above the nailing fin. The flashing should extend approximately 1" beyond the side flashing on both sides of the opening. It should also cover the tops of the side flashing. See illustration.



New Construction Sliding Door Installation Instructions

21

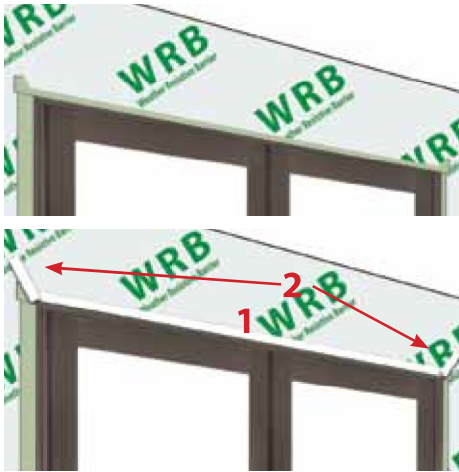

Fold Down the Top WRB & Tape

- a) Remove the tape that is temporarily holding the top WRB flap out of the way.
- b) Fold the WRB flap down so that it covers the top flashing.
- c) Using WRB tape, first tape along the top of the unit. Then tape down the angled side seams of the WRB, making sure that the side tape overlaps the horizontal tape. See illustration.

22

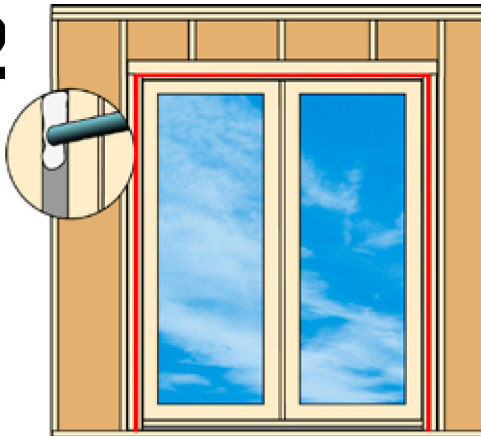

Seal Interior Seams with Low Expansion Foam

Using Low Expanding Foam made for windows and doors, apply around the perimeter of the door, between the edges of the door frame and the wall framing.

Exterior Wall Treatments: Information for the Masonry Installer

Avoiding Call Backs Tip!

Provide Clearance Between Product and Masonry & other exterior treatments

Be sure to allow the following:

- Minimum 1/8" on sides, head and sill for all non-masonry treatments.
- Minimum 1/4" on sides and head of masonry treatments
- Minimum 3/8" to 1/2" at the sill of masonry treatments

Why? - The main wall structure will expand, contract and move independently and at a different rate than the masonry wall, often resulting in some shifting and settling of the main wall. This can cause the bottom of exterior frame of the door to contact the masonry wall which in turn exerts upward pressure against the door sill, deforming it and forcing it to contact and bind against the bottom of the panel. This damages the door and prevents it from operating correctly.

23

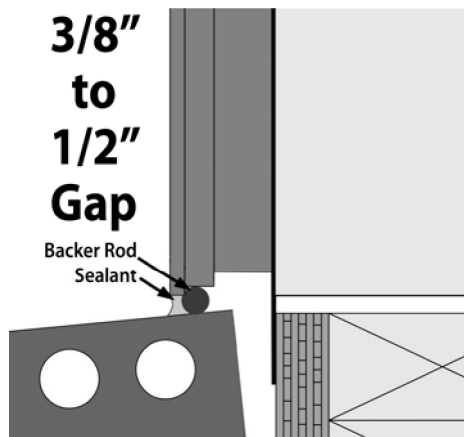

Apply Backer Rod and Sealant to Exterior Perimeter

After the Exterior Wall Treatment is installed . . .

- a) Apply approved sealant to all 1/8" seams.
- b) Apply backer rod and top with sealant all 1/4" and greater seams.



New Construction Sliding Door Installation Instructions

24



Interior Finishing - Wood Surfaces

Wood surfaces must be painted or stained and sealed within 90 days of installation. Follow your finish manufacturers instructions for application of the finish.

25



Install Handle Set

Follow instructions included with the handle set.



New Construction Sliding Door Installation Instructions

Additional Instructions:

Cleaning - Product Surfaces:

Removal of Sun Label - The Sun label can be easily removed by simply peeling it from the glass.

Glass - Use typical household glass cleaner and a soft cloth to clean the glass.

Metal Surfaces - The SunClad exterior aluminum should be washed occasionally with a mild soap and water solution and rinsed with a gentle spray of water. Metal hardware surfaces can be cleaned with a cloth dampened with a mild household cleaner, then polished dry with a clean soft cloth.

Vinyl Surfaces - Clean with a mild soap and water solution and a soft cloth.

Wood Surfaces - Painted and stained wood surfaces should be cleaned according to the finish manufacturer's instructions.

Screens - Remove from the window and wash with a mild soap and water solution. Rinse with a gentle spray of water.

Warnings, Notes, Etc.

- Read All Instructions and Notes. Do not proceed if you are unable to understand and follow these instructions.
- These Instructions are for Typical Wood Frame Construction. Local building codes and other construction concerns may require additional installation instructions per Architect or Building Professional.
- Proper Application of Product: This product is design for typical vertical wall construction. Do not use in roof, sloped walls or aquatic applications.
- To prevent damage to the product and its components, keep product closed and locked throughout all phases of the construction project.
- Failure to follow these installation instructions or the specialized instructions designed by an Architect or Building Professional will void the Product Warranty.
- Read the Sun Product Warranty, available online at www.sunwindows.com/Support/Warranty.html and follow all product application, care and maintenance guidelines. Failure to do so will void the Product Warranty.

- Window and Door products can be heavy. Use caution when handling. Assistance may be needed. Failure to do so may result in injury or damage to the product.
- Prior to installing, do not store the product in direct sunlight. Store in a temperature controlled environment to keep the product from freezing or over heating. Do not stack horizontally. The product may be stacked vertically with additional units, providing no glass surface is load bearing. Failure to do so may result in product damage and will void the Product Warranty.
- Elevated Working Heights - use caution working around unit openings. Follow manufacturers' instructions. Failure to do so may result in injury or death.
- Use of hand and power tools - follow manufacturers' instructions. Failure to do so may result in injury or death.

- Use only Low Expansion Foam designed for windows and doors and follow manufacturers Instructions for application.
- All Product Surfaces must be protected throughout all phases of construction and finishing. Failure to do so will void the Product Warranty.
- Protecting the product from work site conditions and debris is the responsibility of builder, installer, subcontractors
- Raw Wood Surfaces must be protected, properly prepared and finished within 90 days of installation according to the instructions in this document. Failure to do so will void the Product Warranty.
- Chemicals and Cleaning - follow the instructions included in this document for cleaning the product. Do not allow harsh chemicals to contact any of the product surfaces. Failure to protect the product throughout all phases of construction and finishing will void the Product Warranty.
- Follow Glass Cleaning Practices contained in this document. Failure to do so will void the Product Warranty
- Water Management - Proper management of water and moisture is an essential part of any structure. All structures must have a functional, engineered drainage system as part of its exterior finished wall system. Sun Windows, Inc. cannot control or be responsible for water/moisture management beyond the product itself. All products manufactured by Sun Windows must be properly installed as described per these installation instructions. All products manufactured by Sun Windows must be properly flashed and a complete vapor barrier applied to seal the product opening. Proper installation of drainage systems, flashing, water and vapor barriers are the sole responsibility of the owner or their agents. Failure to properly install these systems will void the Product Warranty

***For questions or more information call 1-800-328-1151, Monday to Friday, 8 AM to 4:30 PM Central Time.
For more information visit our website - www.sunwindows.com***